

Article number: 07112050001

Description: Universal joint single 0.112.050.001
S=125 X= Bore with keyway

Measures

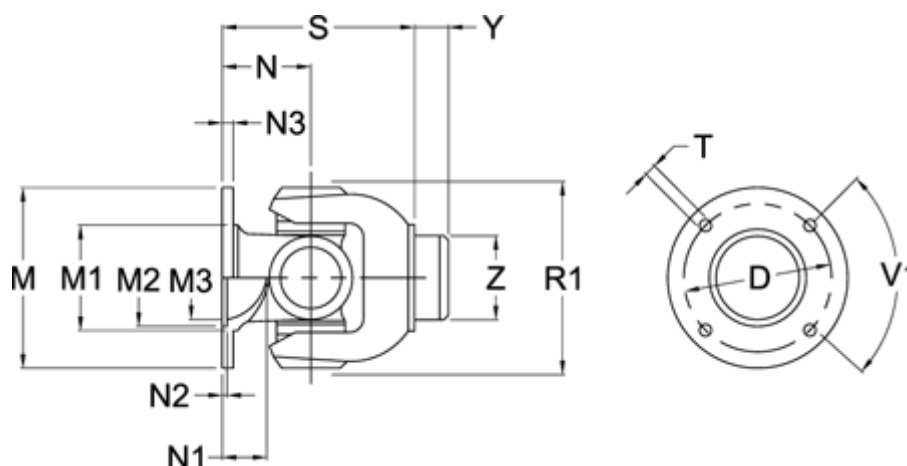

D	= 101,5 \pm 0,1	N2	= 2,5 \pm 0,5	Z = 52.25
Flange diameter M	= 120	N3	= 8	
M1	= 80.5	Number of Flangeholes	= 8	
M2	= 75	R1	= 115	
M3	= 69	S min	= 125	
Max. Bending Angle degrees	= 20	T	= 8 B12	
N	= 60	V1 degrees	= 45	
N1	= 26	Y	= 20	